

Kol. Opis**1 MAGNA1 40-60 F**

Paznja! Slika proizvoda se može razlikovati od stvarnog proizvoda

Proizvodni broj: [99221292](#)

The new MAGNA1 is the simple option for a job well done. It is the perfect choice when replacing older circulators and due to its compliance with the EuP 2015 regulations, substantial savings on electricity is a reality. The ideal choice for basic performance needs in applications where basic system control and monitoring is desired.

- Monitoring via the fault relay, ensuring peace of mind
- Digital start/stop input available for remote pump control
- Continuous operation and reduced downtime with the wireless twin pump function (available on twin-head pumps)
- High energy efficiency resulting in substantial savings on electricity
- Easy setup and operation via the simple user interface
- No maintenance due to the canned-rotor type design.

MAGNA1 is the simple and efficient choice for most applications including

- Heating
 - Main pump
 - Mixing loops
 - Heating surfaces
- Cooling
 - Air conditioning surfaces
 - Ground source heat pump systems
 - Smaller chiller applications

Te nost:

Dizana te nost: voda
Raspon temperature te nosti: 263 .. 383 K
Selected liquid temperature: 333 K
Gustina: 983.2 kg/m³

Tehni ki:

TF klasa: 110
Saglasnosti na natpisnoj plo ici: CE,VDE,EAC,CN ROHS,WEEE

Materijali:

Ku ište pumpe: Liveno gvož e
EN-GJL-250
ASTM A48-250B
Rotor: PES 30%GF

Ugradnja:

Opseg temperature okruženja: 273 .. 313 K
Maksimalni radni pritisak: 1000 kPa
Standardna priрубnica: DIN
Spajanje pumpe: DN 40
Nazivni pritisak: PN6/10
Dužina ugra ivanja: 220 mm

Kol. Opis

Elektri ni podaci:

Potrebna snaga - P1: 12 .. 194 W
Frekvencija struje: 50 / 60 Hz
Potrebni napon: 1 x 230 V
Maksimalna strujna potrošnja: 0.11 .. 1.56 A
Klasa zaštite (IEC 34-5): X4D
Klasa izolacije (IEC 85): F

Ostali:

Energy (EEI): 0.20
Neto masa: 9.5 kg
Bruto masa: 10.5 kg
Shipping volume: 0.016 m³
Finnish LVI No.: 4615319
Country of origin: DE
Custom tariff no.: 84137030

99221292 MAGNA1 40-60 F

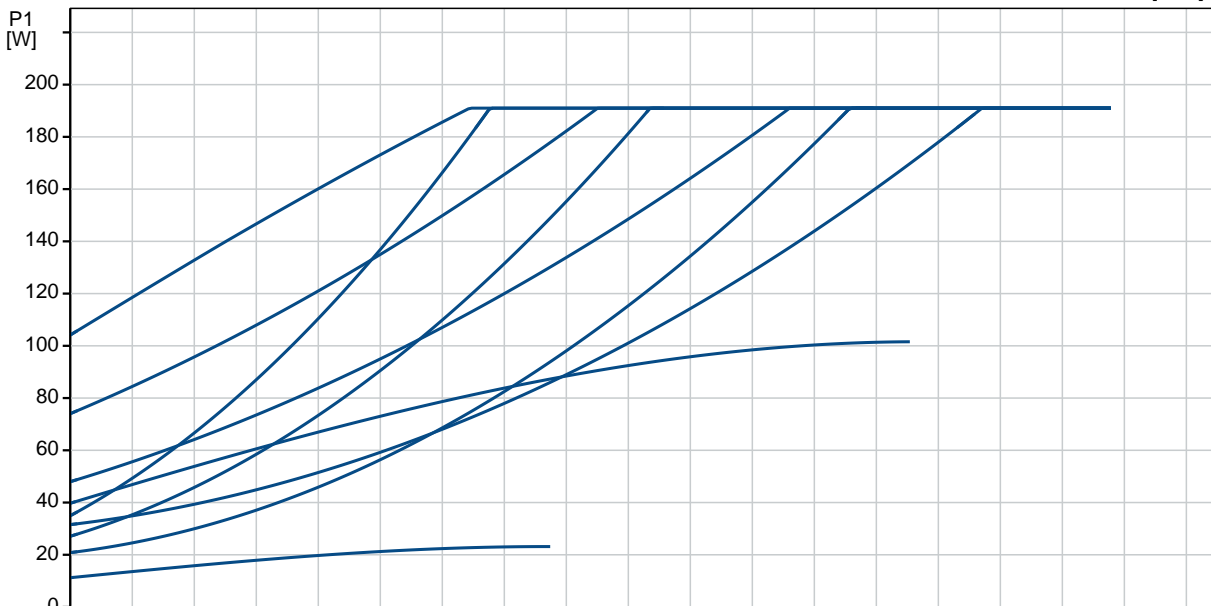
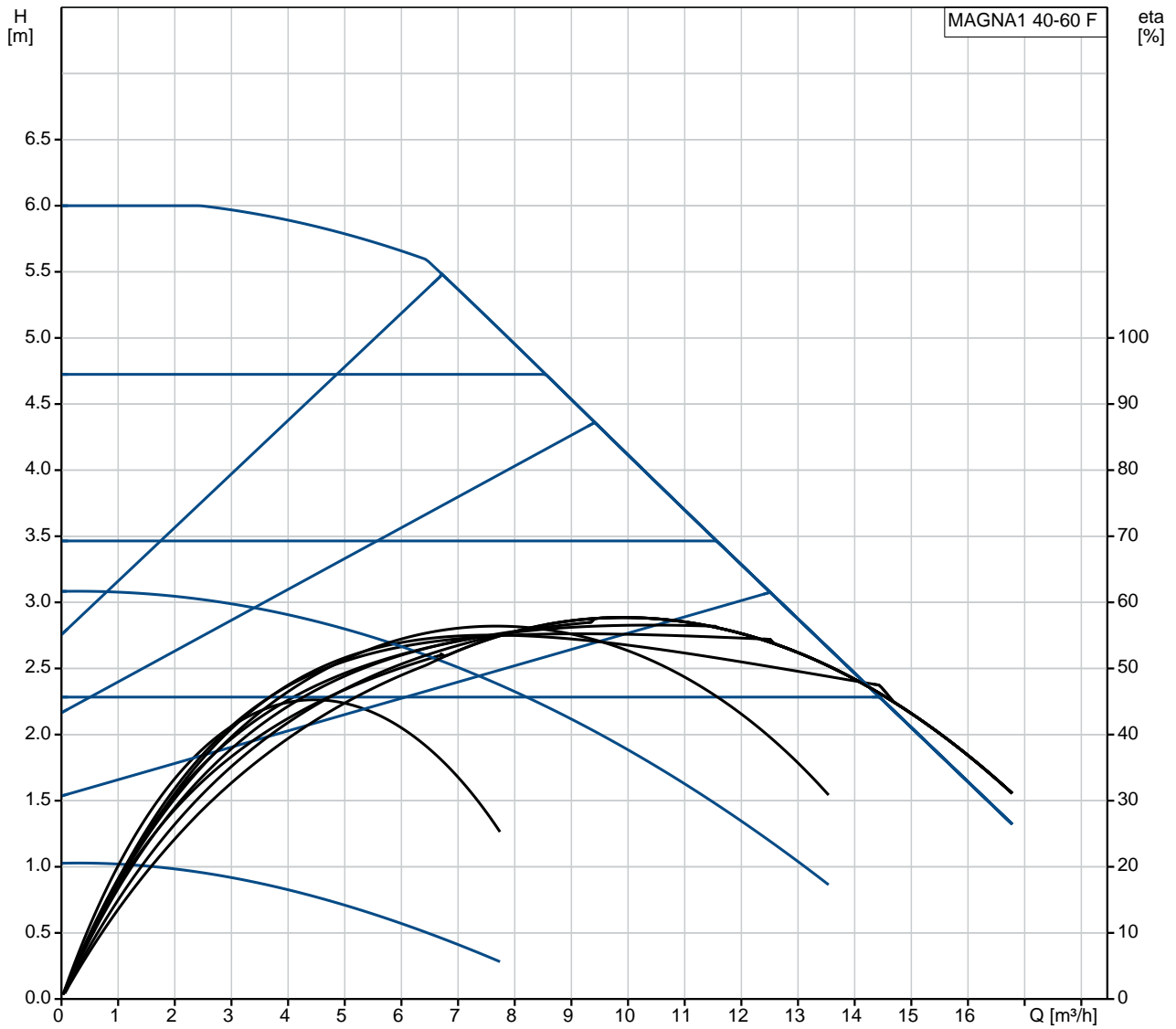

Opis	Vrednost
Opšte informacije:	
Ime proizvoda::	MAGNA1 40-60 F
Šifra proizvoda:	99221292
EAN broj::	5712608942655
	5712608942655
Cena:	774,72 €
Tehni ki:	
Visina max.:	6 m
TF klasa:	110
Saglasnosti na natpisnoj plo ici:	CE, VDE, EAC, CN ROHS, WEEE
Model:	C
Materijali:	
Ku ište pumpe:	Liveño gvož e
	EN-GJL-250
	ASTM A48-250B
Rotor:	PES 30%GF
Ugradnja:	
Opseg temperature okruženja:	273 .. 313 K
Maksimalni radni pritisak:	1000 kPa
Standardna priрубnica:	DIN
Spajanje pumpe:	DN 40
Nazivni pritisak:	PN6/10
Dužina ugra ivanja:	220 mm
Te nost:	
Dizana te nost:	voda
Raspon temperature te nosti:	263 .. 383 K
Selected liquid temperature:	333 K
Gustina:	983.2 kg/m ³
Elektri ni podaci:	
Potrebna snaga - P1:	12 .. 194 W
Frekvencija struje:	50 / 60 Hz
Potrebni napon:	1 x 230 V
Maksimalna strujna potrošnja:	0.11 .. 1.56 A
Klasa zaštite (IEC 34-5):	X4D
Klasa izolacije (IEC 85):	F
Ostali:	
Energy (EEI):	0.20
Neto masa:	9.5 kg
Bruto masa:	10.5 kg
Shipping volume:	0.016 m ³
Finnish LVI No.:	4615319
Country of origin:	DE
Custom tariff no.:	84137030

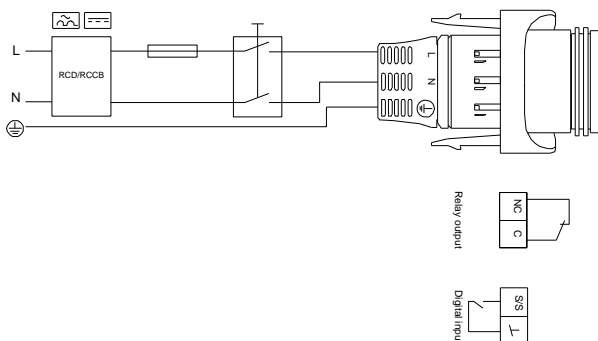
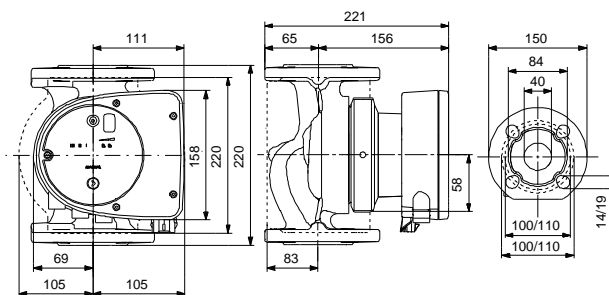
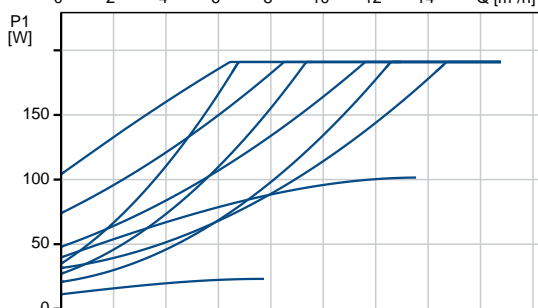
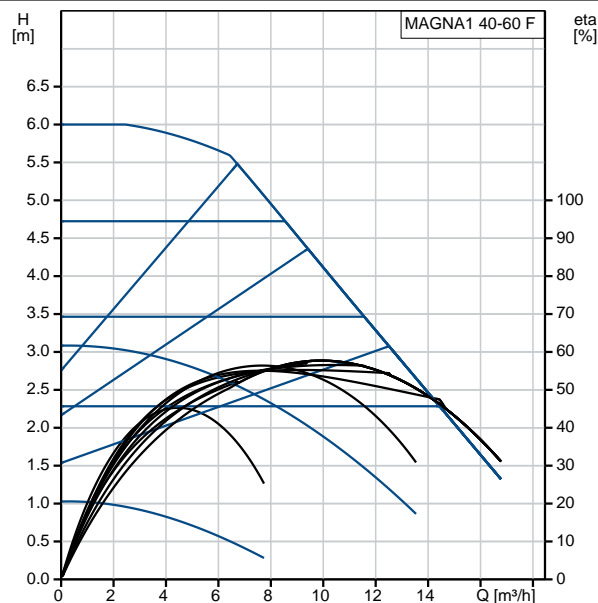

99221292 MAGNA1 40-60 F

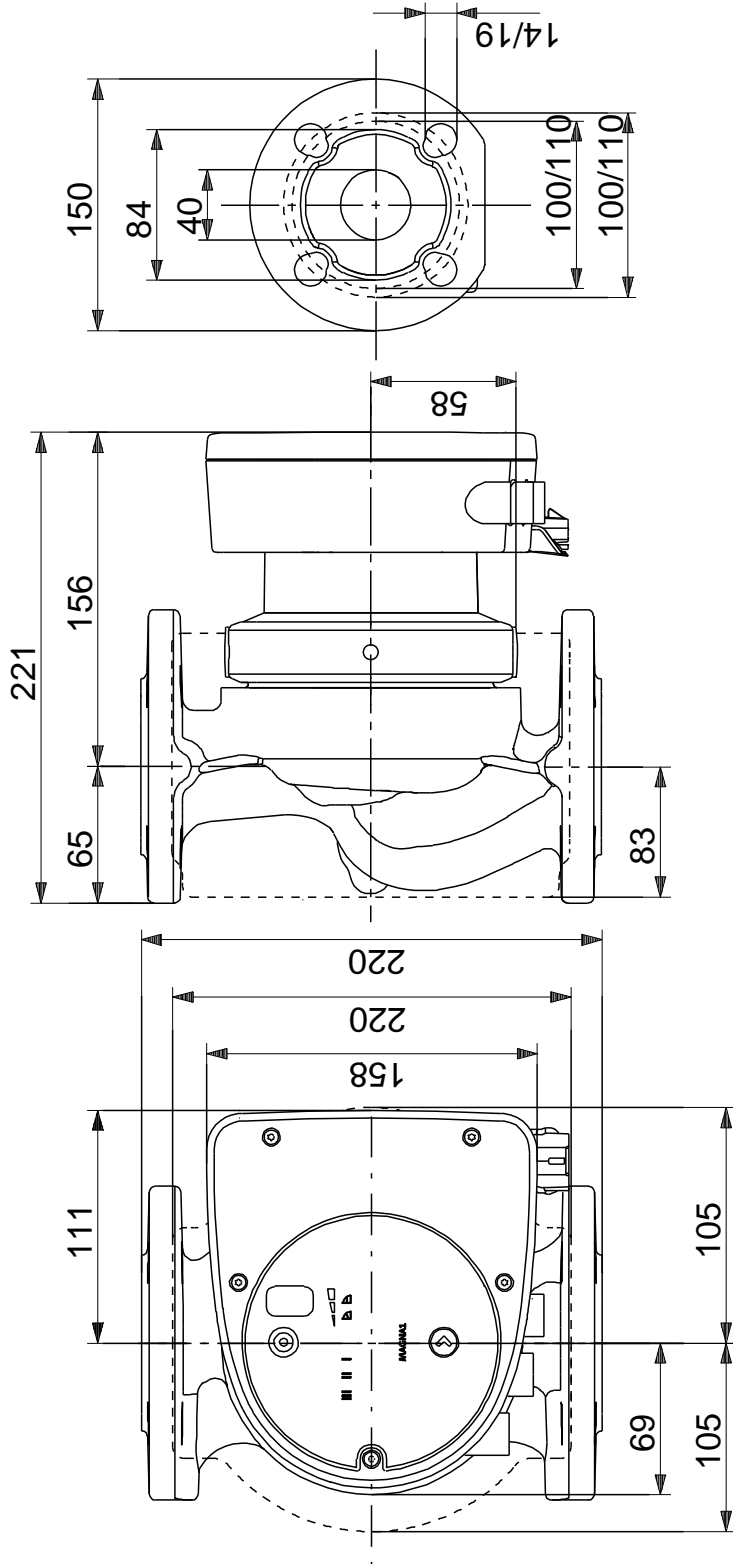

Napomena! Sve jedinice su u [mm]ukoliko druga nije navedeno.
Upozorenje: Ovaj pojednostavljeni dimenzioni crtež ne pokazuje sve detalje.

99221292 MAGNA1 40-60 F

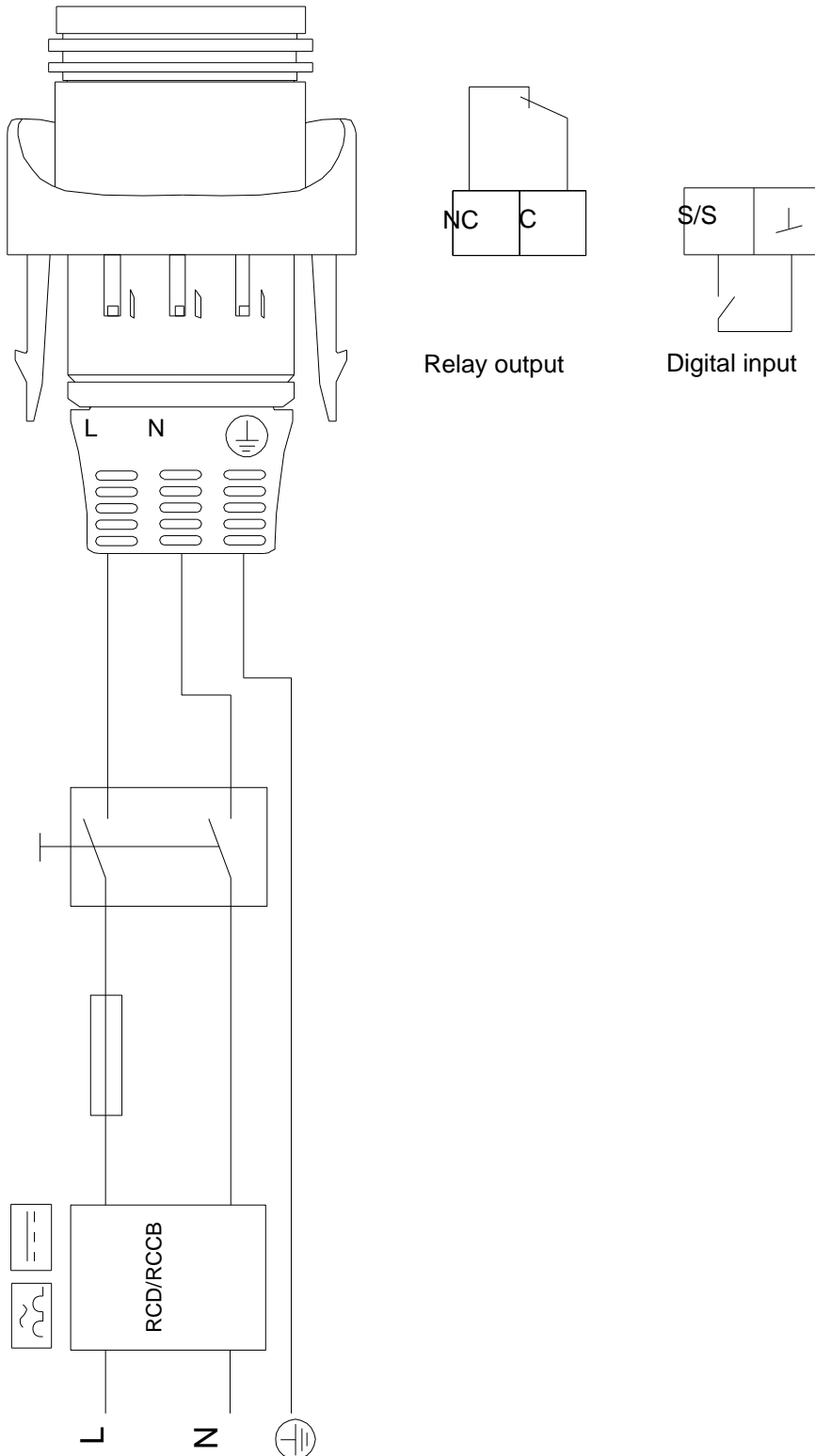

Pažnja! Sve jedinice su u [mm] ukoliko nije re eno druga ije.